

FRE Rohr-Katalog

Gerades Rohr 6 m männlich - weiblich

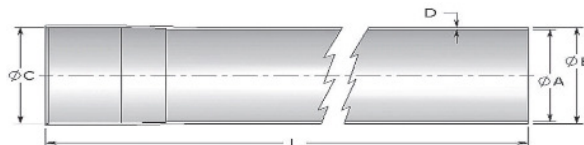

Nr. Art. FRE	Nr. Art. SBB	Größe	Radius
80-4000	314-33-6045	102	0
80-5000 WT	314-33-6075	127	0
80-6000 WT	314-33-6085	152	0

90°-Bogen



Nr. Art. FRE	Nr. Art. SBB	Grösse	Radius
80-4030 R48	314-33-63041	102	1.22
80-4030 R60	314-33-63042		1.52
80-4030 R72	314-33-63043		1.83
80-5030 R48	314-33-63071	127	1.22
80-5030 R60	314-33-63072		1.52
80-5030 R72	314-33-63073		1.83
80-6030 R48	314-33-63081	152	1.22
80-6030 R60	314-33-63082		1.52
80-6030 R72	314-33-63083		1.83

60°-Bogen

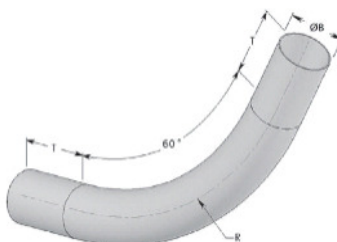

Nr. Art. FRE	Nr. Art. SBB	Grösse	Radius
80-4031 R48	314-33-63141	102	1.22
80-4031 R60	314-33-63142		1.52
80-4031 R72	314-33-63143		1.83
80-5031 R48	314-33-63171	127	1.22
80-5031 R60	314-33-63172		1.52
80-5031 R72	314-33-63173		1.83
80-6031 R48	314-33-63181	152	1.22
80-6031 R60	314-33-63182		1.52
80-6031 R72	314-33-63183		1.83



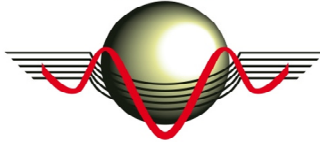

45°-Bogen

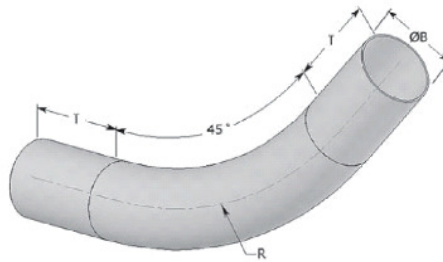

Nr. Art. FRE	Nr. Art. SBB	Grösse	Radius
80-4032 R48	314-33-63241	102	1.22
80-4032 R60	314-33-63242		1.52
80-4032 R72	314-33-63243		1.83
80-5032 R48	314-33-63271	127	1.22
80-5032 R60	314-33-63272		1.52
80-5032 R72	314-33-63273		1.83
80-6032 R48	314-33-63281	152	1.22
80-6032 R60	314-33-63282		1.52
80-6032 R72	314-33-63283		1.83

30°-Bogen

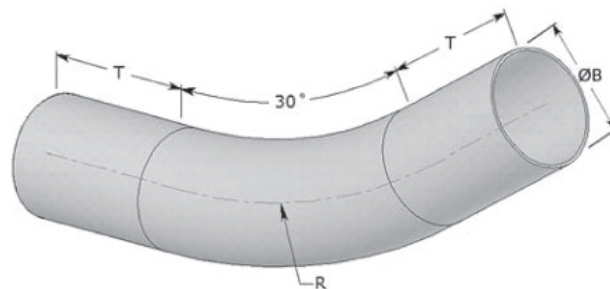

Nr. Art. FRE	Nr. Art. SBB	Grösse	Radius
80-4033 R48	314-33-63341	102	1.22
80-4033 R60	314-33-63342		1.52
80-4033 R72	314-33-63343		1.83
80-5033 R48	314-33-63371	127	1.22
80-5033 R60	314-33-63372		1.52
80-5033 R72	314-33-63373		1.83
80-6033 R48	314-33-63381	152	1.22
80-6033 R60	314-33-63382		1.52
80-6033 R72	314-33-63383		1.83



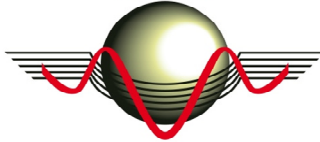

22.5°-Bogen

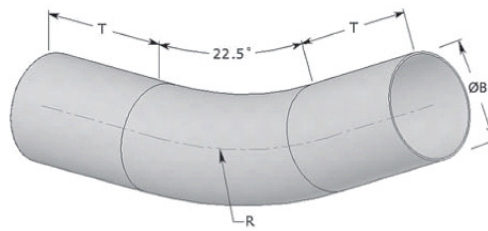

Nr. Art. FRE	Nr. Art. SBB	Grösse	Radius
80-4034 R48	314-33-63441	102	1.22
80-4034 R60	314-33-63442		1.52
80-4034 R72	314-33-63443		1.83
80-5034 R48	314-33-63471	127	1.22
80-5034 R60	314-33-63472		1.52
80-5034 R72	314-33-63473		1.83
80-6034 R48	314-33-63481	152	1.22
80-6034 R60	314-33-63482		1.52
80-6034 R72	314-33-63483		1.83

11.25°-Bogen

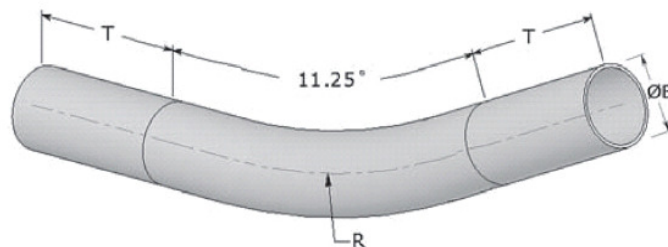

Nr. Art. FRE	Nr. Art. SBB	Grösse	Radius
80-4035 R48	314-33-63541	102	1.22
80-4035 R60	314-33-63542		1.52
80-4035 R72	314-33-63543		1.83
80-5035 R48	314-33-63571	127	1.22
80-5035 R60	314-33-63572		1.52
80-5035 R72	314-33-63573		1.83
80-6035 R48	314-33-63581	152	1.22
80-6035 R60	314-33-63582		1.52
80-6035 R72	314-33-63583		1.83



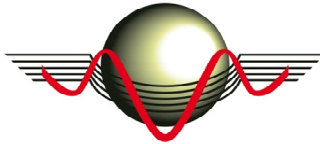

Muffe

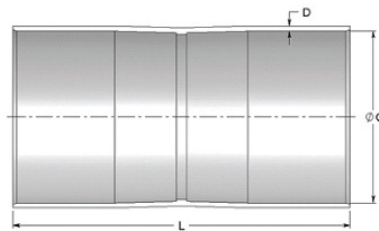

Nr. Art. FRE	Nr. Art. SBB	Grösse	Radius
80-4010	314-33-6044	102	
80-5010 WT	314-33-6047	127	
80-6010 WT	314-33-6048	152	

5°-Muffe

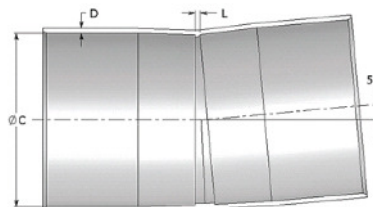

Nr. Art. FRE	Nr. Art. SBB	Grösse	Radius
80-4011 WT	314-33-6144	102	
80-5011 WT	314-33-6147	127	
80-6011 WT	314-33-6148	152	

Schiebemuffe



Nr. Art. FRE	Nr. Art. SBB	Grösse	Radius
80-4016	314-33-60441	102	
80-5016	314-33-60471	127	
80-6016	314-33-60481	152	

gedichteter und flexibler Kompensator O'ri

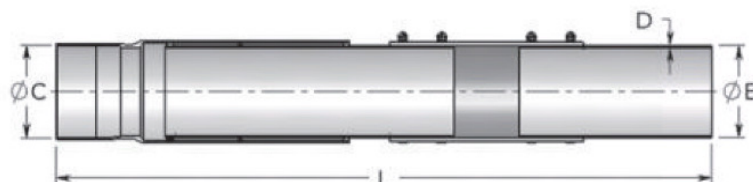

Nr. Art. FRE	Nr. Art. SBB	Grösse	Radius
80-4057 WT	314-33-6241	102	
80-5057 WT	314-33-6271	127	
80-6057 WT	314-33-6281	152	



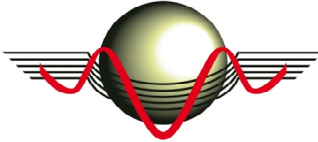

Reduktionsmuffe

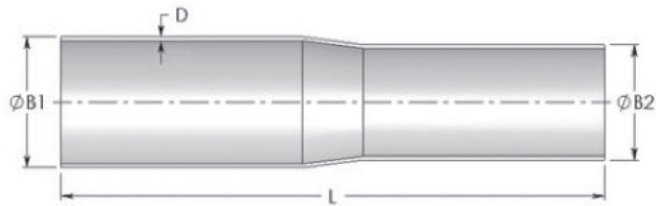

Nr. Art. FRE	Nr. Art. SBB	Grösse	Radius
80-4029 WT	314-33-6341	102	
80-5029 WT	314-33-6371	127	
80-6029 WT	314-33-6381	152	

Adapter 11,25° R5 Stecker-Buchse

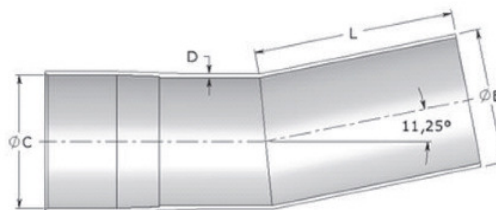

Nr. Art. FRE	Nr. Art. SBB	Grösse	Radius
80-4035 WT	314-33-6441	102	
80-5035 WT	314-33-6471	127	
80-6035 WT	314-33-6481	152	

End Krone (Trompete)

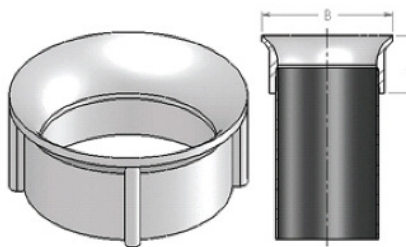

Nr. Art. FRE	Nr. Art. SBB	Grösse	Radius
40-4018	314-33-6054	102	
40-5018	314-33-6057	127	
40-6018	314-33-6058	152	



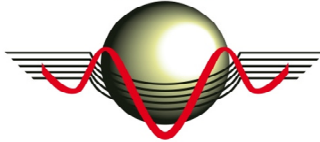

Untere Elemente für Rohre

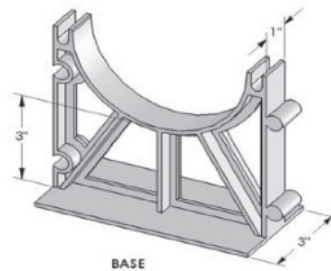

Nr. Art. FRE	Nr. Art. SBB	Grösse	Radius
45-0103	314-33-6941	102	
45-0116	314-33-6971	127	
45-0117	314-33-6981	152	

Mittlere Elemente für Rohre

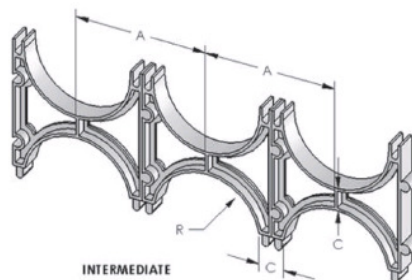

Nr. Art. FRE	Nr. Art. SBB	Grösse	Radius
45-0108	314-33-6942	102	
45-0125	314-33-6972	127	
45-0127	314-33-6982	152	

Obere Elemente für Rohre

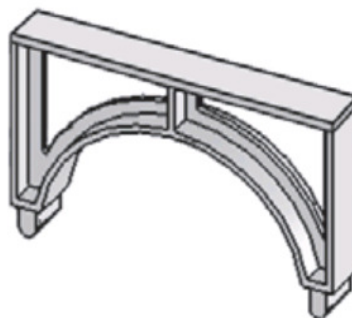

Nr. Art. FRE	Nr. Art. SBB	Grösse	Radius
45-0126	314-33-6943	102	
45-0129	314-33-6973	127	
45-0132	314-33-6983	152	

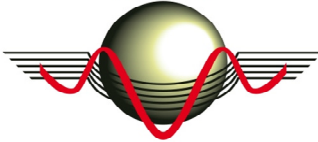

Geschlitztes Rohr Gerades 6 m männlich - weiblich, Ohne H-Formgebung und Band

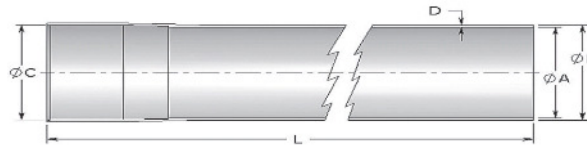

Beispiel zur Verlegung



Nr. Art. FRE	Nr. Art. SBB	Größe	Radius
80-6100 WT	314-33-60851	152	0

-Formgebung 3 m lang für Geschlitzte Röhre

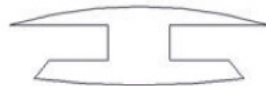

Nr. Art. FRE	Nr. Art. SBB	Größe	Radius
40-0169	314-33-6992		

Dünne T-Formgebung 3 m lang

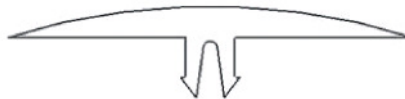

Nr. Art. FRE	Nr. Art. SBB	Größe	Radius
40-0167	314-33-6991		

Schlauchschelle Rapid



Nr. Art. FRE	Nr. Art. SBB	Größe	Radius
SAJ-40-6198		150/170	



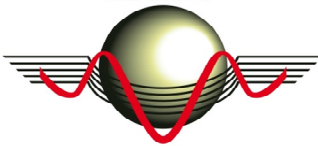

2-komponentiger Klebesatz

Nr. Art. FRE	Nr. Art. SBB	Grösse	Radius
20-0164	314-36-50		



Leimpistole

Nr. Art. FRE	Nr. Art. SBB	Grösse	Radius
20-0165	314-36-51		



Installation Verbundseife

Nr. Art. FRE	Nr. Art. SBB	Grösse	Radius
20-0166	314-36-53		

Anmerkung zum Angebot :

Für Rohr und Bogen 102 ist mit einer Lieferzeit von mindestens 13 Wochen zu rechnen (nicht auf Lager).

Für Rohr und Bogen 127 ist mit einer Lieferzeit von mindestens 13 Wochen zu rechnen (reduzierter Lagerbestand).

Für Rohr und Bogen 152 ist mit einer Lieferzeit von mindestens 3 Wochen zu rechnen. (falls vorrätig)

Andere Radien und Eckradien können mit einer Mindestlieferzeit von 15 Wochen geliefert werden (nicht auf Lager).

Bitte beachten Sie die folgende Gebrauchsanweisung:

- 1) Aus Garantiegründen müssen die Installationsarbeiten an FRE-Röhren von einem zugelassenen Unternehmen durchgeführt oder von von Sajat SA/FRE anerkannten Spezialisten ständig überwacht werden.
- 2) Wenn Sajat SA die gesamten Installationsarbeiten ausführt, verwaltet das Unternehmen allein auch den gesamten Bestand vor Ort. (ohne Transport)
- 8) Unbenutzte Geräte werden weder zurückgenommen noch ausgetauscht.
- 11) Die Aushubsohle ist zu nivellieren, anzupassen und zu verdichten.
- 15) Die Rohre dürfen nicht durch Bürsten, sondern müssen mit einem Schwamm mit einem Durchmesser von 180 mm gereinigt werden.

Die Art.ikel-Nr. 80-40** entspricht einem 102 mm Rohr.

Die Art.ikel-Nr. 80-50** entspricht einem 127 mm Rohr.

Art.ikel Nr. 80-60** entspricht einem genormten 152 mm Rohr für 15kV SBB-

Art.ikel Nr. 80-61** entspricht einem geschlitzten 152 mm Rohr.

