

## Catalogue de tubes FRE

### Tube avec manchon

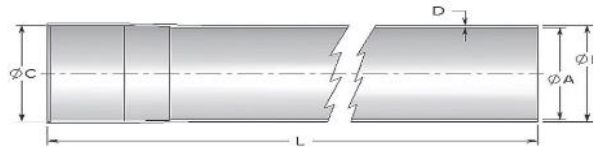

N° art. FRE	N° art CFF	Grandeur	Rayon
80-4000	314-33-6045	102	0
80-5000 WT	314-33-6075	127	0
80-6000 WT	314-33-6085	152	0

### Coude fixe 90°



N° art. FRE	N° art CFF	Grandeur	Rayon
80-4030 R48	314-33-63041	102	1.22
80-4030 R60	314-33-63042		1.52
80-4030 R72	314-33-63043		1.83
80-5030 R48	314-33-63071	127	1.22
80-5030 R60	314-33-63072		1.52
80-5030 R72	314-33-63073		1.83
80-6030 R48	314-33-63081	152	1.22
80-6030 R60	314-33-63082		1.52
80-6030 R72	314-33-63083		1.83

### Coude fixe 60°

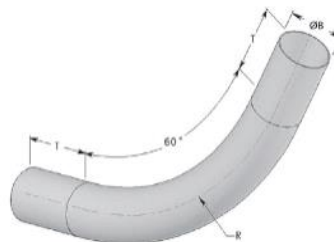

N° art. FRE	N° art CFF	Grandeur	Rayon
80-4031 R48	314-33-63141	102	1.22
80-4031 R60	314-33-63142		1.52
80-4031 R72	314-33-63143		1.83
80-5031 R48	314-33-63171	127	1.22
80-5031 R60	314-33-63172		1.52
80-5031 R72	314-33-63173		1.83
80-6031 R48	314-33-63181	152	1.22
80-6031 R60	314-33-63182		1.52
80-6031 R72	314-33-63183		1.83



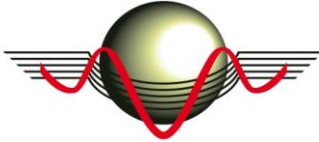

### Coude fixe 45°

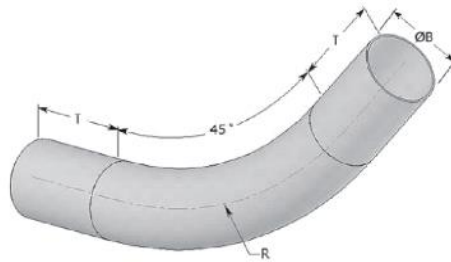

N° art. FRE	N° art CFF	Grandeur	Rayon
80-4032 R48	314-33-63241	102	1.22
80-4032 R60	314-33-63242		1.52
80-4032 R72	314-33-63243		1.83
80-5032 R48	314-33-63271	127	1.22
80-5032 R60	314-33-63272		1.52
80-5032 R72	314-33-63273		1.83
80-6032 R48	314-33-63281	152	1.22
80-6032 R60	314-33-63282		1.52
80-6032 R72	314-33-63283		1.83

### Coude fixe 30°

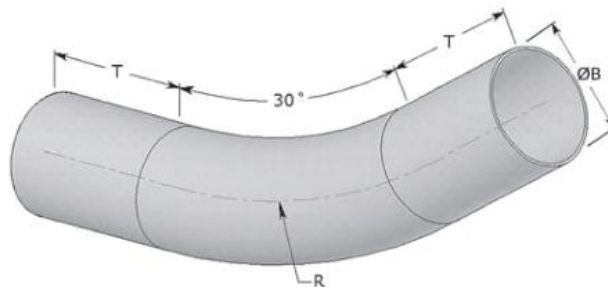

N° art. FRE	N° art CFF	Grandeur	Rayon
80-4033 R48	314-33-63341	102	1.22
80-4033 R60	314-33-63342		1.52
80-4033 R72	314-33-63343		1.83
80-5033 R48	314-33-63371	127	1.22
80-5033 R60	314-33-63372		1.52
80-5033 R72	314-33-63373		1.83
80-6033 R48	314-33-63381	152	1.22
80-6033 R60	314-33-63382		1.52
80-6033 R72	314-33-63383		1.83



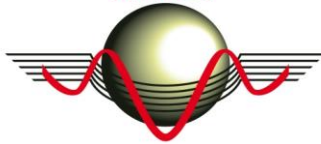

### Coude fixe 22.5°

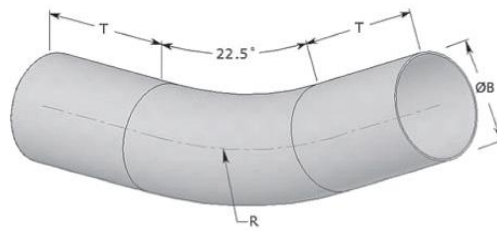

N° art. FRE	N° art CFF	Grandeur	Rayon
80-4034 R48	314-33-63441	102	1.22
80-4034 R60	314-33-63442		1.52
80-4034 R72	314-33-63443		1.83
80-5034 R48	314-33-63471	127	1.22
80-5034 R60	314-33-63472		1.52
80-5034 R72	314-33-63473		1.83
80-6034 R48	314-33-63481	152	1.22
80-6034 R60	314-33-63482		1.52
80-6034 R72	314-33-63483		1.83

### Coude fixe 11.25°

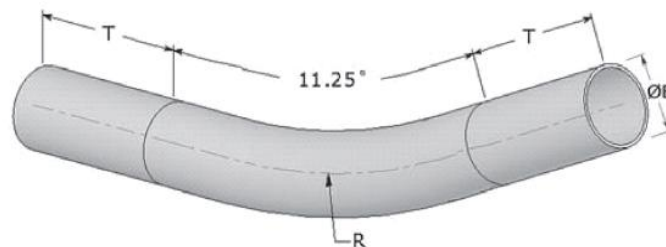

N° art. FRE	N° art CFF	Grandeur	Rayon
80-4035 R48	314-33-63541	102	1.22
80-4035 R60	314-33-63542		1.52
80-4035 R72	314-33-63543		1.83
80-5035 R48	314-33-63571	127	1.22
80-5035 R60	314-33-63572		1.52
80-5035 R72	314-33-63573		1.83
80-6035 R48	314-33-63581	152	1.22
80-6035 R60	314-33-63582		1.52
80-6035 R72	314-33-63583		1.83





**Manchon**

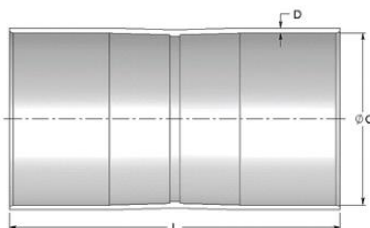

N° art. FRE	N° art CFF	Grandeur	Rayon
80-4010	314-33-6044	102	
80-5010 WT	314-33-6047	127	
80-6010 WT	314-33-6048	152	

**Manchon coudé 5°**

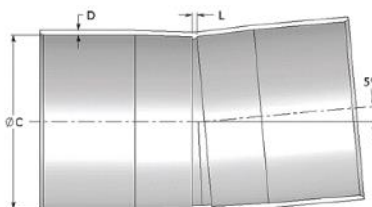

N° art. FRE	N° art CFF	Grandeur	Rayon
80-4011 WT	314-33-6144	102	
80-5011 WT	314-33-6147	127	
80-6011 WT	314-33-6148	152	

**Manchon coulissant**

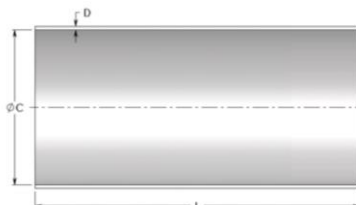

N° art. FRE	N° art CFF	Grandeur	Rayon
80-4016		102	
80-5016		127	
80-6016		152	

**Raccord de dilatation**

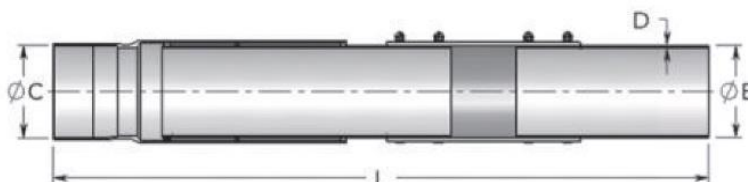

N° art. FRE	N° art CFF	Grandeur	Rayon
80-4057 WT	314-33-6241	102	
80-5057 WT	314-33-6271	127	
80-6057 WT	314-33-6281	152	



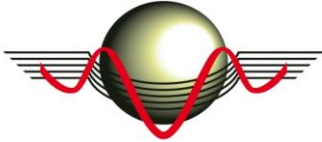

### Réduction

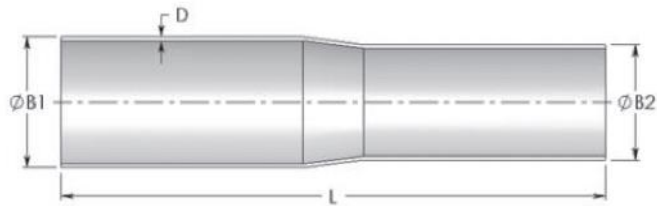

N° art. FRE	N° art CFF	Grandeur	Rayon
80-4029 WT	314-33-6341	102	
80-5029 WT	314-33-6371	127	
80-6029 WT	314-33-6381	152	

### Adaptateur 11.25°

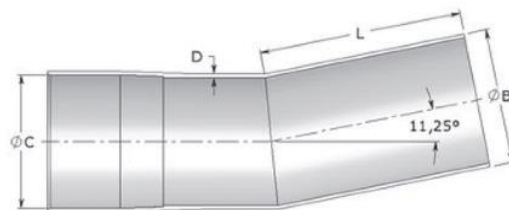

N° art. FRE	N° art CFF	Grandeur	Rayon
80-4035 WT	314-33-6441	102	
80-5035 WT	314-33-6471	127	
80-6035 WT	314-33-6481	152	

### Couronne terminale

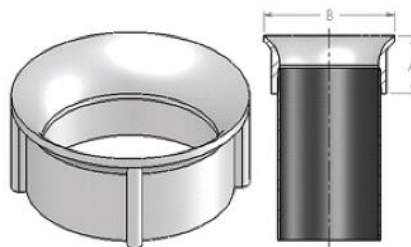

N° art. FRE	N° art CFF	Grandeur	Rayon
40-4018	314-33-6054	102	
40-5018	314-33-6057	127	
40-6018	314-33-6058	152	



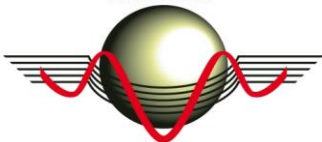

### Éléments pour batterie de tubes Bas

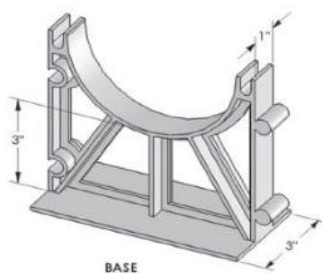

N° art. FRE	N° art CFF	Grandeur	Rayon
45-0103	314-33-6941	102	
45-0116	314-33-6971	127	
45-0117	314-33-6981	152	

### Éléments pour batterie de tubes Milieu

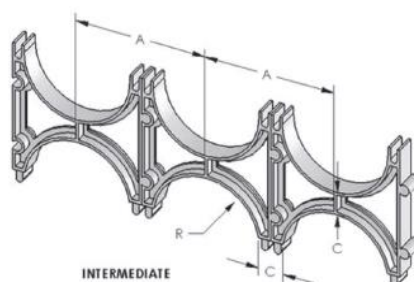

N° art. FRE	N° art CFF	Grandeur	Rayon
45-0108	314-33-6942	102	
45-0125	314-33-6972	127	
45-0127	314-33-6982	152	

### Éléments pour batterie de tubes Haut

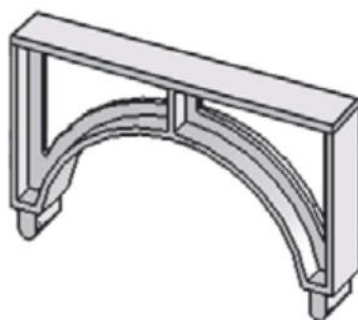

N° art. FRE	N° art CFF	Grandeur	Rayon
45-0126	314-33-6943	102	
45-0129	314-33-6973	127	
45-0132	314-33-6983	152	

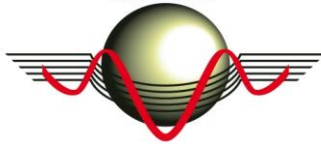

### Moulure pour tubes fendu H

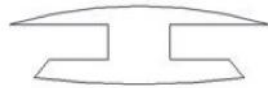

N° art. FRE	N° art CFF	Grandeur	Rayon
40-0167	314-33-6100		

### Moulure pour tubes fendu T

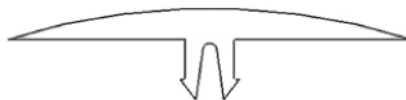

N° art. FRE	N° art CFF	Grandeur	Rayon
40-0169	314-33-6101		

### Kit de colle avec embout mélangeur



N° art. FRE	N° art CFF	Grandeur	Rayon
20-0164	314-36-50		

### Pistolet à colle



N° art. FRE	N° art CFF	Grandeur	Rayon
20-0165	314-36-51		

### Savon d'emboîtement

N° art. FRE	N° art CFF	Grandeur	Rayon
20-0166	314-36-53		

Pour le tube et coude de 102, il faut compter avec un délai de livraison de 13 semaines minimum (pas en stock).

Pour le tube et coude de 127, il faut compter avec un délai de livraison de 6 semaines minimum (stock réduit).

Pour le tube et coude de 152, il faut compter avec un délai de livraison de 3 semaines minimum. (si de stock)

